

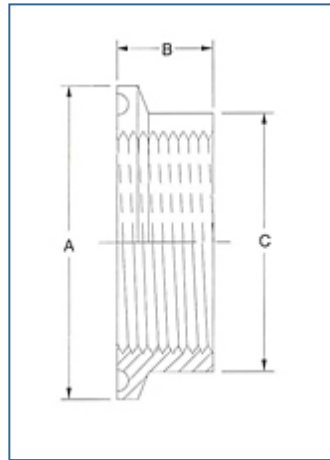

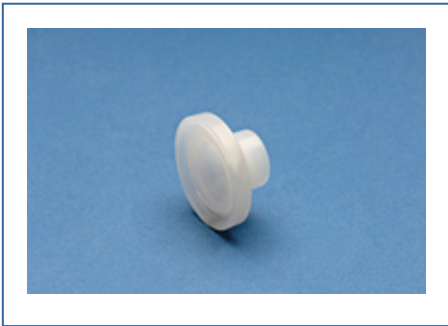























Sani-Tech® End Cap with FNPT Tap

- Use to connect MNPT components to a Sanitary system
- Available in a wide range of sizes from 3/4" to 4"
- Available in polypropylene or PVDF materials



Item #	Tri-Clamp Size	FNPT	A	B	C	Material	CAD
TEC075-02F	MINI	1/8	0.992 in	0.500 in	0.750 in	Polypropylene	
TEC075-04F	MINI	1/4	0.992 in	0.500 in	0.750 in	Polypropylene	
TEC100-02F	MAXI	1/8	1.500 in	0.500 in	1.106 in	Polypropylene	
TEC100-04F	MAXI	1/4	1.500 in	0.500 in	1.106 in	Polypropylene	
TEC100-06F	MAXI	3/8	1.500 in	0.500 in	1.106 in	Polypropylene	
TEC100-08F	MAXI	1/2	1.500 in	0.500 in	1.106 in	Polypropylene	
TEC150-02F	1 1/2	1/8	1.984 in	0.500 in	1.606 in	Polypropylene	
TEC150-04F	1 1/2	1/4	1.984 in	0.500 in	1.606 in	Polypropylene	
TEC150-06F	1 1/2	3/8	1.984 in	0.500 in	1.606 in	Polypropylene	

Item #	Tri-Clamp Size	FNPT	A	B	C	Material	CAD
TEC150-08F	1 1/2	1/2	1.984 in	0.500 in	1.606 in	Polypropylene	
TEC150-10F	1 1/2	5/8	1.984 in	0.500 in	1.606 in	Polypropylene	
TEC150-12F	1 1/2	3/4	1.984 in	0.500 in	1.606 in	Polypropylene	
TEC150-14F	1 1/2	7/8	1.984 in	0.500 in	1.606 in	Polypropylene	
TEC150-16F	1 1/2	1	1.984 in	0.500 in	1.606 in	Polypropylene	
TEC200-02F	2	1/8	2.516 in	0.500 in	2.106 in	Polypropylene	
TEC200-04F	2	1/4	2.516 in	0.500 in	2.106 in	Polypropylene	
TEC200-06F	2	3/8	2.516 in	0.500 in	2.106 in	Polypropylene	
TEC200-08F	2	1/2	2.516 in	0.500 in	2.106 in	Polypropylene	
TEC200-10F	2	5/8	2.516 in	0.500 in	2.106 in	Polypropylene	
TEC200-12F	2	3/4	2.516 in	0.500 in	2.106 in	Polypropylene	
TEC200-14F	2	7/8	2.516 in	0.500 in	2.106 in	Polypropylene	
TEC200-16F	2	1	2.516 in	0.500 in	2.106 in	Polypropylene	
TEC250-02F	2 1/2	1/8	3.047 in	0.500 in	2.606 in	Polypropylene	
TEC250-04F	2 1/2	1/4	3.047 in	0.500 in	2.606 in	Polypropylene	
TEC250-06F	2 1/2	3/8	3.047 in	0.500 in	2.606 in	Polypropylene	



4040 Norex Drive, Chaska MN 55318
 phone: 952.448.4412 | fax: 952.448.6180
 sales@smithengineeringinc.com
 www.smithengineeringinc.com