

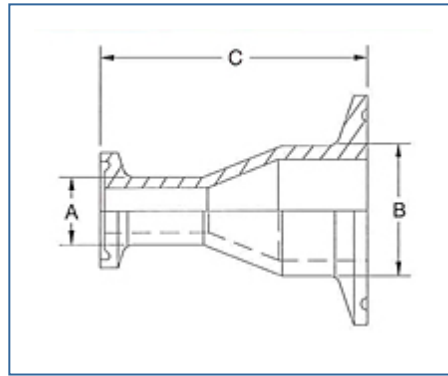

























Sani-Tech® Concentric Reducer

- Sanitary Reducing connector, Concentric
- Sizes: 3/4", 1", 1-1/2", 2", 2-1/2" and 3"
- Available in polypropylene or PVDF materials



<u>Item #</u>	<u>Reducers</u>	<u>A</u>	<u>B</u>	<u>C</u>	<u>Material</u>	<u>CAD</u>
<u>TAD100-075</u>	MINI x MAXI	0.750 in	1.106 in	3.000 in	Polypropylene	
<u>TAD100L-075</u>	MINI x 1 LADISH	0.750 in	1.106 in	3.000 in	Polypropylene	
<u>TAD150-075</u>	MINI x 1 1/2	0.750 in	1.606 in	3.000 in	Polypropylene	
<u>TAD200-075</u>	MINI x 2	0.750 in	2.106 in	3.000 in	Polypropylene	
<u>TAD250-075</u>	MINI x 2 1/2	0.750 in	2.606 in	3.000 in	Polypropylene	
<u>TAD300-075</u>	MINI x 3	0.750 in	3.106 in	3.000 in	Polypropylene	
<u>TAD100L-100</u>	MAXI x 1 LADISH	1.106 in	1.106 in	3.000 in	Polypropylene	
<u>TAD150-100</u>	MAXI x 1 1/2	1.106 in	1.606 in	3.000 in	Polypropylene	
<u>TAD200-100</u>	MAXI x 2	1.106 in	2.106 in	3.000 in	Polypropylene	
<u>TAD250-100</u>	MAXI x 2 1/2	1.106 in	2.606 in	3.000 in	Polypropylene	

Item #	Reducers	A	B	C	Material	CAD
<u>TAD300-100</u>	MAXI x 3	1.106 in	3.106 in	3.000 in	Polypropylene	
<u>TAD150-100L</u>	1 LADISH x 1 1/2	1.106 in	1.606 in	3.000 in	Polypropylene	
<u>TAD200-100L</u>	1 LADISH x 2	1.106 in	2.106 in	3.000 in	Polypropylene	
<u>TAD250-100L</u>	1 LADISH x 2 1/2	1.106 in	2.606 in	3.000 in	Polypropylene	
<u>TAD300-100L</u>	1 LADISH x 3	1.106 in	3.106 in	3.000 in	Polypropylene	
<u>TAD200-150</u>	1 1/2 x 2	1.606 in	2.106 in	3.000 in	Polypropylene	
<u>TAD250-150</u>	1 1/2 x 2 1/2	1.606 in	2.606 in	3.000 in	Polypropylene	
<u>TAD300-150</u>	1 1/2 x 3	1.606 in	3.106 in	3.000 in	Polypropylene	
<u>TAD250-200</u>	2 x 2 1/2	2.106 in	2.606 in	3.250 in	Polypropylene	
<u>TAD300-200</u>	2 x 3	2.106 in	3.106 in	4.850 in	Polypropylene	
<u>TAD300-250</u>	2 1/2 x 3	2.606 in	3.106 in	4.850 in	Polypropylene	
<u>KAD100-075</u>	MINI x MAXI	0.750 in	1.106 in	3.000 in	PVDF	
<u>KAD100L-075</u>	MINI x 1 LADISH	0.750 in	1.106 in	3.000 in	PVDF	
<u>KAD150-075</u>	MINI x 1 1/2	0.750 in	1.606 in	3.000 in	PVDF	
<u>KAD200-075</u>	MINI x 2	0.750 in	2.106 in	3.000 in	PVDF	



4040 Norex Drive, Chaska MN 55318
 phone: 952.448.4412 | fax: 952.448.6180
 sales@smithengineeringinc.com
 www.smithengineeringinc.com