

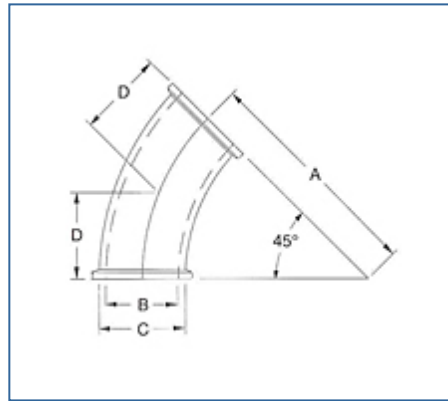













Sani-Tech® 45° Elbow

- Sanitary x Sanitary 45° Elbow allows for smooth bend transition
- Sizes: 3/4", 1", 1-1/2", 2", 2-1/2" and 3"
- Available in polypropylene or PVDF materials



Item #	Size	A	B	C	D	Material	CAD
T45075	MINI	2.5 in	0.560 in	0.750 in	0.96 in	Polypropylene	
T45100	MAXI	2.5 in	0.856 in	1.106 in	0.96 in	Polypropylene	
T45100L	LADISH	2.5 in	0.856 in	1.106 in	0.96 in	Polypropylene	
T45150	1 1/2	4.250 in	1.356 in	1.606 in	1.630 in	Polypropylene	
T45200	2	4.250 in	1.856 in	2.106 in	1.630 in	Polypropylene	
T45250	2 1/2	4.250 in	2.356 in	2.606 in	1.630 in	Polypropylene	
T45300	3	5.000 in	2.856 in	3.106 in	1.910 in	Polypropylene	
K45075	MINI	2.5 in	0.560 in	0.750 in	0.96 in	PVDF	
K45100	MAXI	2.5 in	0.856 in	1.106 in	0.96 in	PVDF	
K45100L	LADISH	2.5 in	0.856 in	1.106 in	0.96 in	PVDF	

<u>Item #</u>	<u>Size</u>	<u>A</u>	<u>B</u>	<u>C</u>	<u>D</u>	<u>Material</u>	<u>CAD</u>
<u>K45150</u>	1 1/2	4.250 in	1.356 in	1.606 in	1.630 in	PVDF	
<u>K45200</u>	2	4.250 in	1.856 in	2.106 in	1.630 in	PVDF	
<u>K45250</u>	2 1/2	4.250 in	2.356 in	2.606 in	1.630 in	PVDF	
<u>K45300</u>	3	5.000 in	2.856 in	3.106 in	1.910 in	PVDF	

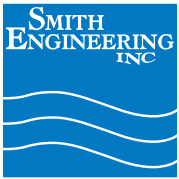

4040 Norex Drive, Chaska MN 55318
phone: 952.448.4412 | fax: 952.448.6180
sales@smithengineeringinc.com
www.smithengineeringinc.com